

Article number: 439500300
 Description: Rota-fix shaft-hub connection F300x375
 Steel
 Note: Self centering. Very high torque

Measures

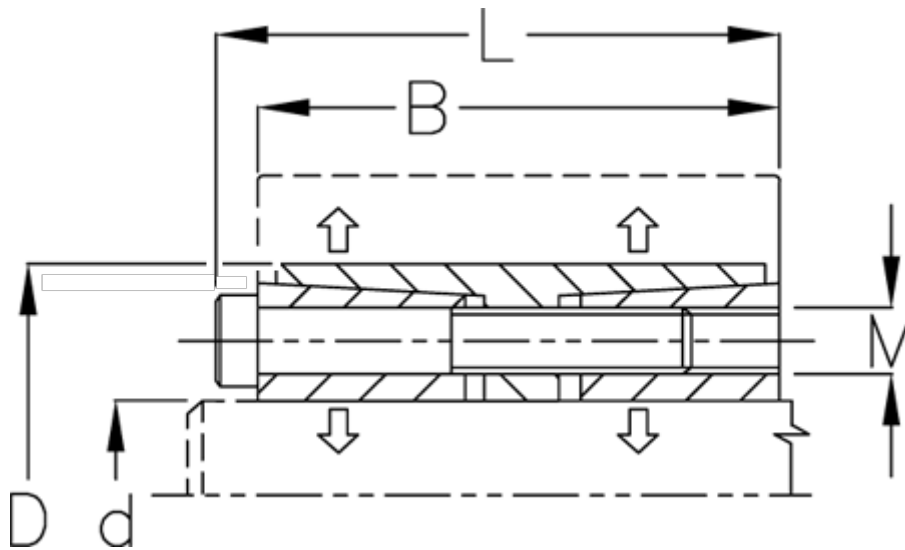

B mm	= 177
d H8 mm	= 300
D mm	= 375
Fit tolerance	= Aksel h8, Nav H8
F kN torque	= 2500.0
L mm	= 197
M mm	= M20
P N/mm ² surface pressure on shaft/hub	= 110

Surface roughness	= R? ? 3.2 µm
T N m torque	= 375000
Ts N m bolt tightening torque	= 690.0